

DISLOCATION MODELS AS TEACHING AIDS

C. B. Garcia, C. K. Endo, M. Chang, G. E. Beltz

Department of Mechanical and Environmental Engineering, University of California, Santa Barbara, CA 93106.

ABSTRACT

Perfect crystal lattices are used to teach students about the microscopic structures of materials. Students also learn about specific defects, which occur in all materials, such as dislocations, whose geometries are often difficult to visualize. Consequently, drawings and ball-and-stick models are commonly used to help students visualize individual edge and screw dislocations. In an attempt to improve the visualization process, foam models of both screw and edge dislocations were created. Measurements of the models were made to determine their relative accuracy in comparison to the theoretical elastic stress and strain fields of dislocations. The models are shown to make excellent visual aids because they enhance a student's understanding of how a crystal lattice reacts when a dislocation is introduced.

Keywords: *Dislocation models; edge dislocations; screw dislocations.*

INTRODUCTION

In engineering, drawings are used to communicate ideas as a convenient, fast, and effective method. Unfortunately, drawings are limited to two dimensions. In most cases, drawings can sufficiently explain three dimensional phenomena, but in the study of materials, it is often difficult to correctly visualize microscopic structures. Ball-and-stick models are also used to help students better understand the microscopic structures of materials. These models illustrate the atomic structure of various crystal lattices and are good teaching tools, but they lack the flexibility to accurately illustrate the deformation and displacement that occurs when a dislocation is introduced into a crystal.

Foam models were created to help students better understand the movement of a crystal lattice when a dislocation is introduced. The highly elastic properties of the foam provided a good medium for the models. Moreover, when the foam was displaced to produce a dislocation, its response was similar to those of atoms in a crystal lattice. Foam "crystals" were easily manipulated to present a relatively accurate picture of the displacement of the atomic positions around a dislocation. Portrayal of the elastic behavior of the lattice also provides beneficial information about the deformations imposed on the structure, which a student might have difficulty visualizing. In addition, more complicated defects such as mixed-character dislocations and disclinations are possible to visualize using these foam models.

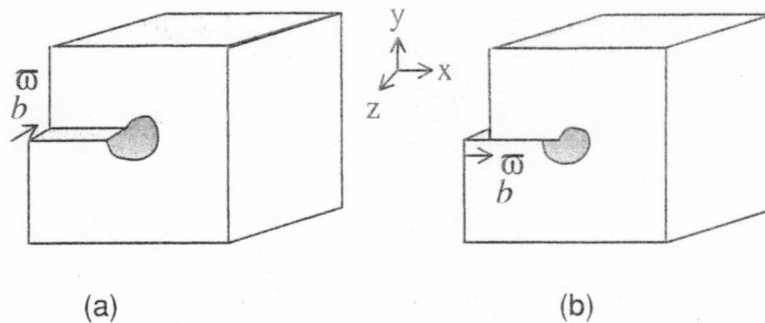

Figure 1. A screw (a) and edge dislocation (b) with the Burger's vector representing the direction and magnitude of the dislocation.

BACKGROUND

When students are initially introduced to material structures, they are taught to assume a perfect crystal lattice. However, in reality most materials are permeated with flaws due to impurities in the materials and manufacturing processes. Dislocations are linear defects, which cause a crystal lattice to shift and distort from the ideal configuration. The presence of dislocations and other flaws can significantly change the properties of a material, such as the electric and thermal conductivity, fracture strength, yield strength, and thermal conductivity. For example, metal ductility was an unexplained behavior until the discovery of crystal dislocations. Since then, it has become well known that materials with numerous dislocations, such as metals, will have increased ductility, and nearly perfect crystals will tend to be more brittle.

A Burgers vector and the dislocation line itself define a dislocation. Screw dislocations occur when the crystal lattice is shifted by one atomic spacing, usually by a shear stress, and the Burgers vector is parallel to the dislocation line. Similarly, an edge dislocation is said to occur when an extra half plane of atoms displaces the crystal lattice, and their Burgers vector is perpendicular to the dislocation line. Dislocations create a localized lattice distortion, as shown in Figure 1, imposing stresses and

strains that do not occur in a perfect crystal. It is important to study the elastic properties induced by the dislocations, as they often change material properties. Frenkel calculated the theoretical critical shear stress of a crystal in 1926¹ as:

$$\tau_{th} = \frac{b G}{a 2\pi} \quad (1)$$

where b is the spacing between the atoms in the direction of shear, a is the spacing of atoms perpendicular to shear, and G is the shear modulus. However, experimental results of the resolved shear stress are many magnitudes lower than the predictions. This disparity is explained by the presence of dislocations. Dislocations rarely occur as pure edge or screw character, and are usually of mixed character. However, mixed dislocations are difficult to visualize and are usually not considered in undergraduate courses.

ELASTIC THEORY

As a dislocation is introduced to the structure, the atoms are displaced from their original position with a resulting stress and strain field around the dislocation. This displacement can be represented by a vector defining the change in position, $U(x,y,z)$.

The Screw Dislocation

To determine the stresses and strains associated with a screw dislocation, an equation that describes how the dislocation displaces the lattice is needed. The displacement around a screw dislocation can be derived as ²:

$$U_z = \frac{b\theta}{2\pi} \quad (2)$$

where b is the Burgers vector, and θ is the position around the z -axis. There are no displacements in the x and y directions; U_x and U_y equal zero.

The Edge Dislocation

The derivation of the equations representing the displacement in the x , y , and z directions of the crystal lattice is more complex for the edge dislocation. In the case of the edge dislocation, the lattice does not displace in the z -direction; strain is found only in the x - y plane. The displacement field for an edge dislocation is derived to be ²:

$$U_x = \frac{b}{2\pi} \left[\tan^{-1} \frac{y}{x} + \frac{xy}{2(1-\nu)(x^2 + y^2)} \right]$$

$$U_y = \frac{b}{2\pi} \left[\frac{1-2\nu}{4(1-\nu)} + \frac{xy}{2(1-\nu)(x^2 + y^2)} \right] \quad (3)$$

where ν is Poisson's ratio. The displacement equations shown above (equations (2) and (3)), for screw and edge dislocations, were used to evaluate how accurately the models represent the theory. Since the models are for use as visual aids, these were the only equations necessary for determining the models' accuracy.

EXPERIMENTAL DETAILS

Required Equipment

- 12"x 12"x 6" high density foam blocks
- 12"x 12" sheets of transparent plastic or film
- 11-inch piece of a 2-inch diameter aluminum pipe
- 1-inch piece of a 2-inch diameter solid aluminum rod
- Rubber cement
- Band saw
- Drill press
- Lath

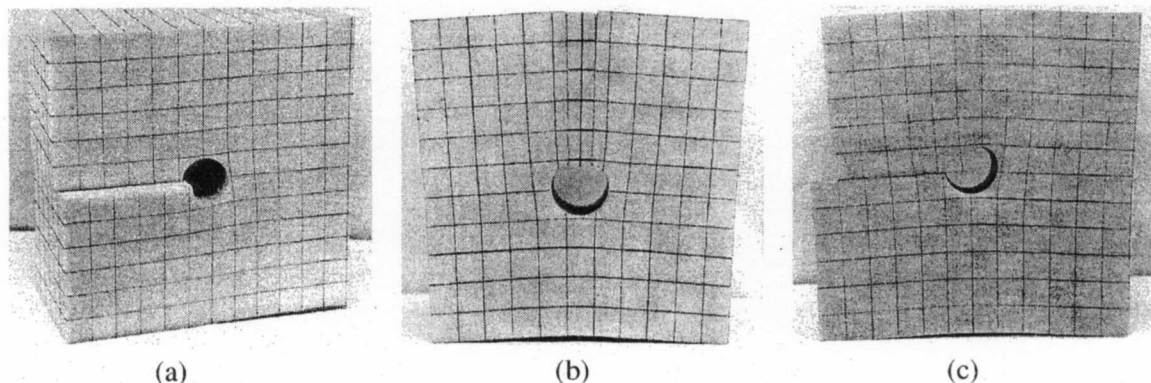

Figure 2. Edge Dislocation Models. (a) Screw dislocation (b) Edge dislocation using a wedge of foam as the extra half plane. (c) Edge dislocation made with a continuous piece of foam displaced by one Burger's vector.

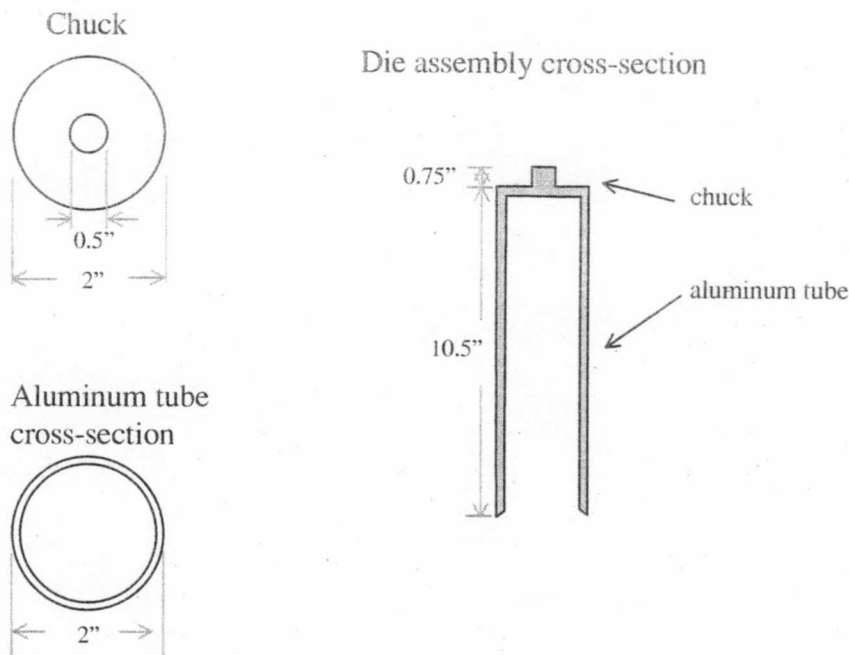

Figure 3. Die assembly, constructed from aluminum

Model Fabrication

In developing the use of foam blocks for dislocation models, two techniques for making edge models and one for screw models were implemented. One of the edge dislocations was made from a single, continuous piece of foam, while the other used an extra wedge of foam to simulate the extra half-plane of atoms of an edge dislocation. The screw dislocation was made simply from one piece of foam. See Figure 2 for pictures of the models.

A one-inch grid was drawn onto uncut blocks of foam, with each intersection on the grid representing a lattice point. Transparent film was placed on top face of the foam block and the grid accurately traced onto the film. The film will be placed upon the deformed foam and used to measure the relative displacements of the lattice sites.

To introduce the dislocation into the foam, a cylindrical "dislocation core" must first be removed from the block to accommodate the

displacement without tearing the foam. To cut an accurate core, an aluminum rod and pipe were machined, aligned, and welded together as shown in Figure 3. The die was attached to a drill press and used to cut a core out of the center of the foam block as shown in Figure 4.

Once the core was removed, cuts were made along the dislocation line as shown in Figure 4. For Figure 4b, a "plane" of atoms was cut off one side of the cube in addition to the center cut, and then cut in half to serve as the half-plane of atoms for an edge dislocation. The grid was then shifted by one Burgers vector and glued in place to represent the desired dislocation. In the models shown here, the Burgers vector was set equal to one lattice spacing. For the edge dislocation made with the extra wedge of foam, the extra half-plane was aligned and glued into the cut.

DISCUSSION

Once the models were assembled, the accuracy of the models was determined. The previously

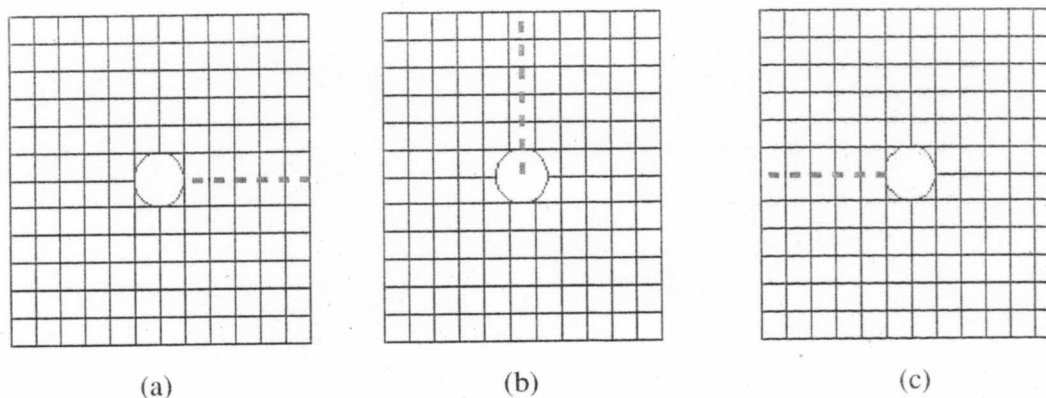

Figure 4. The location of the cuts for the dislocation line. Cuts should be made along the dotted lines: (a) screw dislocation, (b) edge dislocation made with a wedge, (c) continuous edge dislocation.

prepared gridded transparent film was placed over the displaced foam form and the change from the original position for each lattice point was measured. The displacements of the model were compared with the expected displacements from theory and showed that while the displacements were certainly not exact, they did show the expected trends.

Edge Dislocation Model 1

This model was made with the extra half plane of foam added. It was a good representation of how the lattice would deform if an actual dislocation had permeated the crystal lattice. However, the displacement of the lattice points was more exaggerated than those calculated from the equations (see Figure 5). Of the two edge dislocations, the extra half-plane method showed better results. Although the model is not an exact representation of the theoretical placement of the lattice points, it does establish a trend demonstrating to the student generally how the lattice would deform in the presence of an edge dislocation.

Edge Dislocation Model 2

Figure 6 shows that the results from this model were not as accurate as those from the other

model. However, it did provide an alternate method to simulating an edge dislocation. The extra plane needed to form an edge dislocation in this model was created by displacing the upper half of the foam model along the cut toward the center by one Burgers vector. This eliminated the need to glue the extra plane into the model.

After making the edge dislocation models, the foam near the top was noted to be pulling apart where the extra half plane of foam was added and compressed near the bottom of the model. According to theory, the material above the dislocation line should be in compression and in tension underneath the line. It was suspected that the problem was due to the small size of the models; that is, the models only represented a small region of atoms (~144 atoms) around a dislocation. A simple finite element analysis showed that size was indeed a factor. When the analysis was done for a substantially larger group of atoms, the effects due to the edges of the foam block were minimized, suggesting that larger models (or smaller lattice spacing) would result in more accurate edge dislocations. However, larger models would diminish the visual impact of the dislocation, which is the main intent of the models.

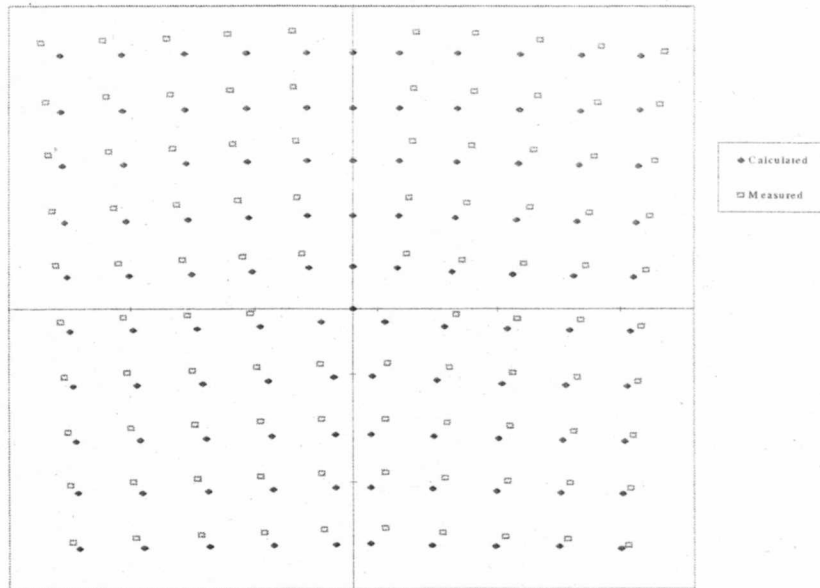

Figure 5. The calculated and measured position of each lattice point on Edge 1 model. The points on the positive y-axis represent the inserted extra half plane of atoms.

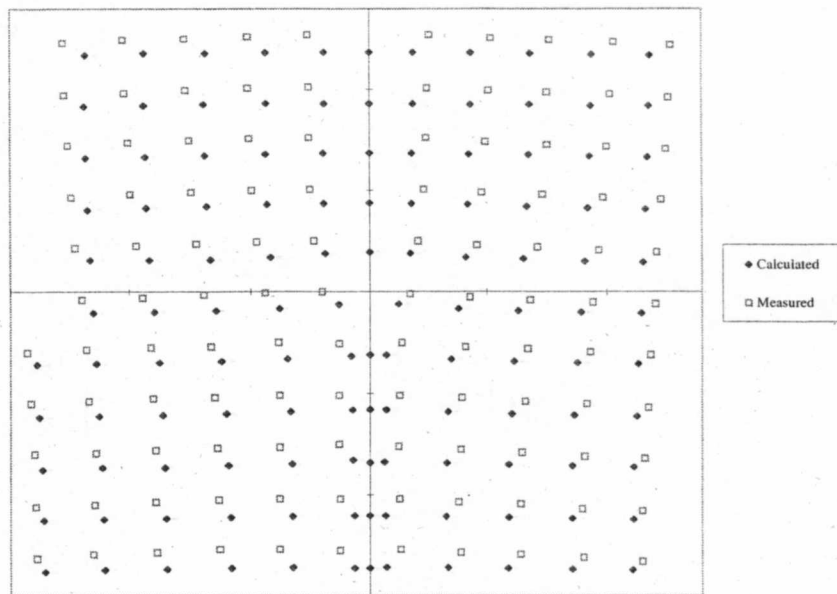

Figure 6. Measured and calculated positions of lattice points from Edge 2 model

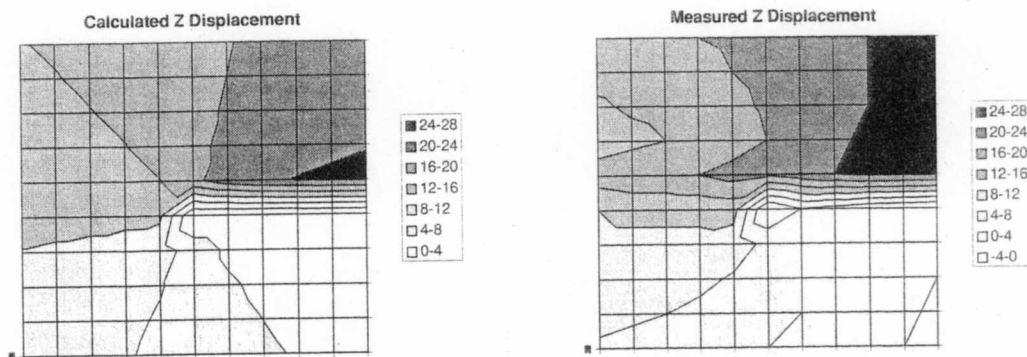

Figure 7. The contour graphs represent the displacement in the z direction for both the theoretical values and those measured from the model.

Screw Dislocation Model

This model produced results that were closest to the theory even though the displacement measurements were difficult to attain. After the model was displaced an inch in the z -direction, it was set on a level surface. A guide was made from a ruler and secured on each side so that it could hover over the model and maintain a constant distance from the table. Measurements were taken at each lattice point of the distance from the guide to the surface of the model and plotted as shown in Figure 7. These results showed that the foam screw dislocation model behaved similar to how the theoretical prediction, and was a good visual description of a screw dislocation.

CONCLUSIONS

The foam used to make the models proved to be a good medium to simulate how a dislocation affects a crystal lattice. Finite element analysis showed that the tensile and compressive stresses that remained after the displacement would approach zero as the material became infinitely large, suggesting that larger models would show improved accuracy.

The dislocation models illustrated the geometric and structural effects of dislocations on a

crystal. The study of the models' accuracy showed that the macroscopic dislocations in the models created displacements not unlike those predicted by established theory. Overall, the models proved to be excellent visual representations of the edge and screw dislocations by offering students a three-dimensional depiction of the dislocations.

ACKNOWLEDGEMENTS

C. B. Garcia and C. K. Endo were funded through the Summer Apprenticeship Research Initiative sponsored by the Graduate Division at the University of California, Santa Barbara. This work was inspired by prototype foam models developed by R. Cammarata and F. Spaepen over a decade ago for a graduate materials course at Harvard University.

REFERENCES

1. D. Hull and D.J. Bacon, *Introduction to Dislocations*, Pergamon Press, UK, 1984.
2. J.P. Hirth and J. Lothe, *Theory of Dislocations*, Krieger Publishing Company, Florida, 1992.